













83 030 892 Produktversion ab 01.04.2024



- Stichmaß 300 mm
- Breite 355 mm
- Höhe 55 mm
- Rosette Ø 55 mm
- Ausladung 80 mm

	Platin gebürstet	83 030 892-06
	Chrom	83 030 892-00
	Platin	83 030 892-08
	Weiß matt	83 030 892-10
	Dark Brass matt	83 030 892-16
	Dark Bronze matt	83 030 892-17
	Dark Chrome	83 030 892-19
	Light Gold gebürstet	83 030 892-27
	Messing gebürstet (23kt Gold)	83 030 892-28
	Schwarz matt	83 030 892-33
	Bronze gebürstet	83 030 892-42
	Champagne gebürstet (22kt Gold)	83 030 892-46
	Champagne (22kt Gold)	83 030 892-47
	Chrom gebürstet	83 030 892-93
	Dark Platinum gebürstet	83 030 892-99

83 030 892 Produktversion ab 01.04.2024

mm [inches]

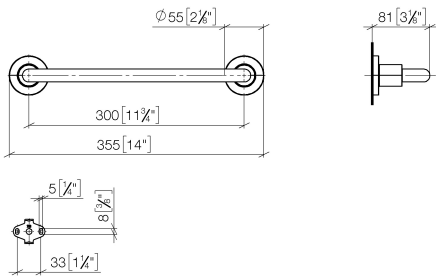

## Codes & Standards

TÜV-Zeichen

## Zertifikate

TÜV\_B0358530023 TÜV\_B0358530023

83 030 892 Produktversion ab 01.04.2024

Ersatzteile für die  
anderen  
Oberflächenvarianten  
finden Sie hier:  
Chrom

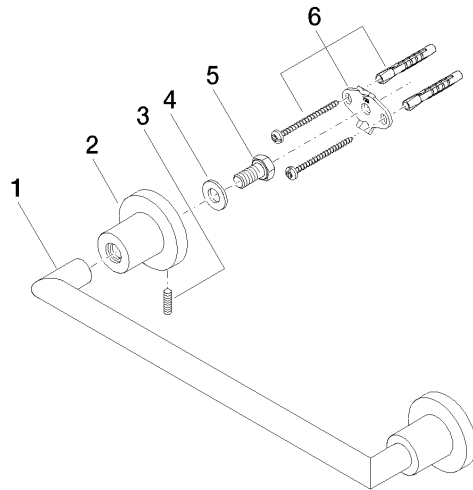

## Ersatzteilstückliste

Nr.	Artikelnummer	Benennung	Verbaumenge	Lieferzeit
2	08 17 89 505-06	Halter universal 60 x 100 x 60 mm - Platin gebürstet	2,00	10
5	09 30 30 071 90	Befestigung Sechskantschraube mit Gewinde bis Kopf M10 x 20 mm -	2,00	2
3	04 31 11 113 00 90	Befestigung Gewindestift M5 x 12 mm -	2,00	2
1	05 28 22 587 00-06	Griff für Wannengriff 318 x 42 x 22 mm - Platin gebürstet	1,00	10
4	09 30 11 046 90	Unterlegscheibe Ø 10,5 -	2,00	2
6	05 17 20 739 00 90	Befestigungssatz 150 x 65 x 10 mm -	2,00	2